



# **ATTREZZATURE SPECIALIZZATE**



## > DAR013

### CENTRAFARI

- Adatto per verificare e regolare qualsiasi tipo di faro (abbaglianti, anabbaglianti e fendinebbia), compresi i fari con XENON e LED.
- Adatto all'uso sia in garage che in linee di controllo tecnico (ITV), per veicoli leggeri e pesanti.
- Schermo di verifica dei fari con scala per veicoli con guida a destra e a sinistra.
- Visiera di allineamento dei cavi in acciaio con sistema di calibratura.
- Meccanismo di regolazione dell'altezza con sistema di bloccaggio.
- Luxmetro digitale.
- Comodo utilizzo grazie al posizionamento delle ruote.
- Robusta base antiribaltamento.
- Fornito con manuali di montaggio, funzionamento e calibratura.

Min. 250	✓
Max.. 1350	

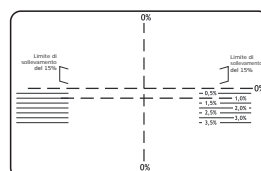

## > DAR016

### CENTRAFARI A LASER DOPPIO

- Adatto per verificare e regolare qualsiasi tipo di faro (abbaglianti, anabbaglianti e fendinebbia), compresi i fari con XENON e LED.
- Adatto all'uso sia in garage che in linee di controllo tecnico (ITV), per veicoli leggeri e pesanti.
- Schermo di verifica regolabile con scala per veicoli con guida a destra e a sinistra.
- Visiera di allineamento laser + puntatore laser centrale per posizionare facilmente l'unità davanti al veicolo.
- Meccanismo di regolazione dell'altezza con sistema di bloccaggio.
- Luxmetro digitale.
- Comodo utilizzo grazie al posizionamento delle ruote.
- Robusta base antiribaltamento.
- Fornito con manuali di montaggio, funzionamento e calibratura
- Tutti i modelli sono compatibili con il Kit assi rotanti rif. 5412/KG (vedere catalogo Accessori).
- Visiera di allineamento laser

Min. 250	✓	✓
Max.. 1350		









Visiera di allineamento laser

> **DAC90.40.D**

**COMPRESSORE A SECCO 90 L**











-  8 bar - 116 PSI
-  90 L
-  2
-  230 V / 1 PH / 50 Hz
-  2+2 Hp - 1,5+1,5 kw
-  1400 rpm
-  90L/min - 13,4CFM - 22m³/h
-  **KG** 72 KG
-  **dB** 68 db

> **DAC150.3W**

**COMPRESSORE A PISTONE 150 L**











-  10 bar - 145 PSI
-  150 L
-  2
-  230 V / 1 PH / 50 Hz
-  3,0 Hp - 2,2 kw
-  1400 rpm
-  315L/min - 11,1 CFM - 18,9m³/h
-  **KG** 86 KG
-  **dB** 75 db

> **DAC200.55**

**COMPRESSORE A PISTONE 200 L**











-  10 bar - 145 PSI
-  200 L
-  2
-  400 V / 3 PH / 50 Hz
-  5,5 Hp - 4 kw
-  1400 rpm
-  606L/min - 21,4 CFM - 36,4m³/h
-  **KG** 139 kg
-  **dB** 81 db



> **DAC270.75**

**COMPRESSORE A PISTONE 270 L**







-  10 bar - 145 PSI
-  270 L
-  2
-  400 V / 3 PH / 50 Hz
-  7,5 Hp - 5,5 kw
-  1400rpm
-  798L/min - 28,2 CFM - 47,9m³/h
-  **KG** 185 KG
-  **dB** 81 db

> **DAC270.55.S**

**COMPRESSORE A PISTONE SILENZIOSO 270 L**









-  10 bar - 145 PSI
-  270 L
-  2
-  400 V / 3 PH / 50 Hz
-  5,5 Hp - 4,0 kw
-  1400 rpm
-  606L/min - 21 CFM - 36m³/h
-  **KG** 248 KG
-  **dB** 68 db

**DAC270.10.T**

**COMPRESSORE A VITE 270 L**



-  10 bar - 145 PSI
-  270 L
-  10,0 Hp - 7,5 kw
-  400 V / 3 PH / 50 Hz
-  1000L/min - 35 CFM - 60m³/h
-  **KG** 204 kg

- > **DAAC1** MACCHINA DI CARICAMENTO REFRIGERANTE 134a
- > **DAAC2** MACCHINA DI CARICAMENTO REFRIGERANTE 1234yf

## MACCHINA DI CARICAMENTO ARIA CONDIZIONATA SEMI-AUTOMATICA REFRIGERANTE

- Ricicla il refrigerante residuo nel climatizzatore dell'automobile.
- Dopo il trattamento, il refrigerante riciclato è conforme allo standard SAE.
- Separa e scarica l'olio del sistema di climatizzazione.
- Sistema di climatizzazione a iniezione d'olio controllato mediante elettrovalvola magnetica.
- Rimuove automaticamente i gas non condensabili nel refrigerante.
- La bilancia elettronica misura il refrigerante riciclato e ricaricato durante l'intero processo.
- Processo controllato da micro-computer.
- Il design della valvola elettromagnetica previene i danni causati dal flusso del liquido.
- Collegamenti autosigillanti rapidi.
- Promemoria automatico del controllo dei problemi e degli allarmi.
- Promemoria automatico degli stati operativi attuali.
- Promemoria automatico della manutenzione giornaliera.



2 (LP y HP)



1/4HP



1.5 CFM



220 V / 1 PH



180W



2 m



88 KG

Velocità di recupero:	3 g/s
Velocità vuoto:	1.0 l/s
Velocità di caricamento:	18 g/s
Capacità serbatoio di lavoro:	10 kg
Capacità filtro a secco:	60 kg
Precisione:	±10 g

- **RECUPERO, RICARICA, VUOTO**
- **BILANCIA INCLUSA**





## > DA322B

### SCAMBIATORE OLIO ATF



**INCLUSO**



70-90 PSI



30 L



230V / 250W



38,5 KG



650 x 520 x 1160 mm



- Connettori inclusi
- \* Consultare modelli e kit optional

VW - Toyota - Honda - Nissan - Mitsubishi - Lexus - Cadillac - Chrysler - Audi - Buick - Chevrolet - Ford - BMW.

## > DA322BKIT

### SET CONNETTORE ATF



CROWN, REIZ, LEXUS IS300, LEXUS ES300, LEXUS GS300, Audi A4, A6, PASSAT 5HP, Cadillac (SRX, XTS), BUICK(LaCrosse, Regal, Excelle, ENCORE, Enclave, GL8), Chevrolet (Spark, Captiva, Cruze, Malibu, Lova, Epica), Dodge cool Bo(CVT), Jeep Compass, Jeep Cherokee, CROWN, REIZ, Roewe, VolvoS40, S60, Audi A4, A6, PASSAT 5H, Landrover Freelander2/3 Roewe750, BMW X5, BMW X6, BMW Series5 Series3, Series 7 BMW X5, Peugeot 207/307, C-QUATRE, C-Triomphe, Peugeot 3008, 4008, Citroen C5/C4, Peugeot3008, CitroenC5/C4, Chevrolet Sail, Volkswagen(Bora, SAGITAR, Lavida, SANTANA, Jetta, Touran), SKODA(Fabia, Octavia, Superb), BESTUN(B50, B70, B90, MPV)09G, Volkswagen(Bora, SAGITAR, Passat, , SANTANA, Jetta, Touran), SKODA(Fabia, Octavia, Superb), BESTUN(B50, B70, B90, MPV)09G, Volkswagen (Bora, SAGITAR, Passat, SANTANA, - Jetta, Touran), SKODA(Fabia, Octavia, Superb), BESTUN(B50, B70, B90, MPV)09G, Volkswagen(Bora, SAGITAR, Lavida, Passat, SANTANA, Jetta, Touran), SKODA(Fabia, Octavia, Superb),

BESTUN(B50, B70, B90, MPV)09G, New Sunny, TIIDA, Bluebird Sylphy, Sunny, Qashqai, NISSAN New Sunny, Teana2.0L, Mitsubishi ASX, SHUTTLE, Benz A.B.C.M.L.E., GL.S, TOYOTA LAND CRUISER, Volkswagen Tiguan, Audi Q7, Touareg, Cayenne, Benz 722.9series, Tiguan, Cayenne, Q7, BMW 3series, 5series, Landrover Range Rover, Discovery, Evoque, BMW 7series , X6, Audi A6(2.5T), Qashqai2.0, 2010 Volkswagen CC, Landrover Evoque, MAZDA C-X5, Volkswagen(SAGITAR, Lavida, - SANTANA, CC, Golf), Audi Q5, A8, Benz SLK/CLK, COROLLA K311, New Audi A6L A4L, A47 Cadillac, Citroen1.6T, Ford, Volvo6, Ford Explorer, VolvoV60, CadillacXT-5, Maserati, Audi Q3, GEELY GLEAGLE GX7/GC7, GeTecEC8, EngLon SC7, Ford Kuga, Volvo XC60, XC90, New Fit/CVT, New Crown, BMW X3 X1 3series Cadillac, 09G Wave box, VolvoS80, Benz B200, MITSUBISHI LancerEX, New Regal Ford1.8 1.6, Cadillac Malibu, BMW 525L1, Audi Q5, Q7, BUICK(LaCrosse, Regal, Excelle, ENCORE, Enclave, GL8) Chevrolet (Captiva Cruze Malibu Epica), Benz, HYUNDAI, GreatWall, FORD Old BMW X3, Volkswagen (Bao Lai, Sagitar, LaVida, Passat, Santana, Jetta, Touran), Skoda (Jingrui, Mingrui, Hao Rui), Pentium (B50, B70, B90, MPV), 09G Gearbox, Volkswagen(Bora, SAGITAR, Lavida, Passat, SANTANA, Jetta, Touran), SKODA(Fabia, Octavia, Superb), BESTUN(B50, B70, B90, MPV)09G, 6HP Gearbox universal, A960E CVT, BMW6HP

## > DA332

### ATF SEMI - AUTOMATICO ELETTRONICO



**INCLUSO**



LCD



230V / 140W



30 L



0.1 L



43,9 KG



595 x 465 x 1115 mm





- Connettori inclusi
- \* Consultare modelli e kit optional

VW - Toyota - Honda - Nissan - Mitsubishi - Lexus - Cadillac - Chrysler - Audi - Buick - Chevrolet - Ford - BMW.

> **DM1200**

**PULITORE A ULTRASUONI 30 L 220 V**

- Serbatoio in acciaio inox pressofuso
- Circuito di livello industriale integrato
- Range di temperatura 0~80°C
- Tempo di lavoro: 0~99 minuti
- Potenza regolabile, funzione di degasaggio
- Funzione di degasaggio e sgrassaggio
- Standby automatico, sospensione e riattivazione con un solo tasto
- Controller digitale ad alta precisione e a lunga durata
- Semionda (28 KHz) per risciacquo grossolano o onda intera (40 KHz) per risciacquo intensivo

-  30 L
-  600W
-  28/40 KHZ
-  10
-  1-99 Min
-  0-80 °C
-  500 W
-  500 x 330 x 380 mm
-  500 x 330 x 200 mm
-  240V
-  500 W



# SERVIZIO DI INSTALLAZIONE ATTREZZATURE





A green can of 'Eco-max' power cleaner is the central focus, positioned vertically. The can features the brand name 'Eco-max' in large, bold, yellow-green letters. Below the name, there are hazard symbols, including a flame and a skull and crossbones. The background is a dark, perforated metal surface, possibly a wall or a large container. The image is framed by two large red diagonal shapes: one in the top-left corner and another in the bottom-right corner. The overall lighting is dim, highlighting the can against the dark background.

**PRODOTTI CHIMICI**



> **140001**  400 ml

### SPRAY MULTIUSO LUBRIFICANTE / DEUMIDIFICANTE / PENETRANTE 400 ML



#### SPECIFICHE

- Prodotto di eccezionale qualità, appositamente formulato per molteplici usi. Penetrante, lubrificante, antiossidante e ad alto potere deumidificante.
- Penetra in profondità liberando le parti corrose, lasciando un film protettivo di MOS2.
- Non danneggia gomma, vetro, vernice, plastica ed è praticamente inodore.
- Ideale per uso industriale, agricolo, aeronautico e navale.

> **140013**  500 ml

### SPRAY DI PULIZIA FRENI 500 ML



#### SPECIFICHE

- Spray detergente multiuso. Pulisce e sgrassa tutti i tipi di parti metalliche, vetro, ceramica e la maggior parte delle materie plastiche. Asciuga velocemente e non lascia residui.
- Uso per freni a disco e a tamburo, guide, cilindri, molle e protezioni in lamiera.
- Frizioni, carburatori e corpi iniezione, collettori di aspirazione, pompe olio e carburante, trasmissioni, parti motore, ecc.

> **DC2.0**  20 g

### SUPERCOLLA CIANOACRILATO 20 G



#### SPECIFICHE

Colla monocomponente, a base di cianoacrilato che reagisce in pochi secondi a temperatura e pressione ambiente. Prodotto senza solventi, incolore ed estremamente aderente.

Incollaggio rapido e permanente di:

- Plastica/plastica
- Gomma/plastica
- Gomma/gomma
- Gomma/metallo
- Metallo/metallo

> **140011**

400

**ZINCO SPRAY TRASPARENTE 400 ML**

## SPECIFICHE

- Agente di zincatura a freddo monocomponente, a base di resine di tipo acrilico, ad alto potere di protezione contro gli agenti corrosivi.
- La sua formula equilibrata contiene zinco puro, alluminio e pigmenti dilatanti che conferiscono al prodotto una colorazione molto chiara, per una buona finitura finale.
- Utilizzato per le finiture o per la protezione contro l'ossidazione di parti zincate, ringhiere, porte, ecc. e in qualsiasi applicazione in cui sia richiesta una finitura trasparente.

**140012**

500 ml

**SPRAY ZINC PURO EP 400 ML**

## SPECIFICHE

- Agente di zincatura a freddo monocomponente, con zinco puro di alta qualità e resine di tipo epossidico.
- Prodotto ad elevato potere anticorrosivo, grazie all'eccellente contenuto di zinco metallico e degli adesivi pigmentati inorganici dilatanti che prevengono la corrosione dei metalli.
- Genera un film grigio opaco, che può essere verniciato o lasciato come protezione finale.

> **140006**

500 ml

**SPRAY CRUSCOTTO 400 ML**

## SPECIFICHE

- Appositamente formulato per la protezione di plastica, gomma e pelle. Può essere utilizzato come lubrificante generico, specialmente su superfici non metalliche e dove è richiesto un lubrificante pulito.
- Ripristino di cruscotti.
- Protezione per gomma.
- Ripristino di plastica, borse.
- Rivestimento per mobili.



> **DL2.22**  50 ml

**SIGILLANTE PER FILETTATURE VIOLA 50 ML**



Colore: Viola

**SPECIFICHE**

- Sicurezza nell'avvitamento
- Aderenza moderata
- Viscosità moderata
- Indurimento rapido
- Per filettature fino a M36
- Metallo/metallo: 10-20 min.
- Tolleranze (D-d) 2 in m/m:
- Raccomandazione: 0.05 Max: 0.12
- Tempo di asciugatura 3-6 ore.
- Resistenza alla temperatura: -60°C + 150°C



> **DL2.42**  50 ml

**SIGILLANTE PER FILETTATURE MEDIO/RAPIDO BLU 50ML**



Colore: Blu

**SPECIFICHE**

- Sicurezza nell'avvitamento
- Aderenza moderata
- Viscosità moderata
- Indurimento rapido
- Per filettature fino a M36
- Metallo/metallo: 10-20 min.
- Tolleranze (D-d) 2 in m/m:
- Raccomandazione: 0.05 Max: 0.12
- Tempo di asciugatura 3-6 ore.
- Resistenza alla temperatura: -60°C + 150°C



> **DL2.70**  50 ml

**SIGILLANTE PER FILETTATURE MEDIO/RAPIDO VERDE 50ML**



Colore: Verde

**SPECIFICHE**

- Tappi e bulloni di sicurezza
- Aderenza extra-forte
- Media viscosità.
- Indurimento rapido.
- Per filettature fino a: M20R½"
- Tolleranze (De) 2 in mm:
- Raccomandazione: 0.05 Max: 0.12
- Metallo / metallo: 10-20 min.
- Tempi di asciugatura: 3-6 ore.
- Resistenza alla temperatura: -60°C + 150°C



**COMPORAMENTO ANAEROBICO, FISSAGGIO, SIGILLATURA E CONSERVAZIONE.**

Queste colle anaerobiche monocomponenti sono appositamente formulate per legare metallo e metallo. Si solidificano in assenza di aria e a temperatura ambiente.

Il prodotto rimane inattivo a contatto con l'ossigeno, pertanto è necessario che il contenitore contenga una parte di aria.

Il suo effetto capillare raggiunge gli spazi più stretti, riempiendo ogni vuoto presente.

Fissa cuscinetti, boccole, viti, dadi in modo permanente.

Per ottenere i migliori risultati, utilizzare uno sgrassante prima dell'applicazione.

> **DL5.72**  50 ml

### SIGILLANTE PER TUBI (PTFE) 50 ML



Colore: Bianco

#### SPECIFICHE

- Sigillatura di tubi (PTFE) Approvato per acqua potabile
- Aderenza media
- Alta viscosità
- Indurimento lento
- Per filettature fino a: R2"
- Tolleranze (D-d) 2 in m/m: Max: 0.3
- Metallo / metallo: 30-60 min.
- Tempi di asciugatura: 6-24 ore
- Resistenza alla temperatura: -55°C + 150°C



> **DL6.01**  50 ml

### GEL PER CONTENIMENTO LIQUIDI 50 ML



Colore: Verde

#### SPECIFICHE

- Applicazioni consigliate: contenimento
- Aderenza extra-forte
- Viscosità moderata
- Indurimento rapido
- Per filettature fino a: M12
- Tolleranze (D-d) 2 in m/m: Raccomandazione: 0.03 Max: 0.08
- Metallo/metallo: 10-20 min.
- Tempi di asciugatura: 3-6 ore
- Resistenza alla temperatura: -60°C + 150°C





> **DL6.38**  50 ml

**GEL PER CONTENIMENTO LIQUIDI AD ALTA RESISTENZA 50 ML**

Colore: Verde



**SPECIFICHE**

- Applicazioni consigliate: sicurezza nell'avvitamento
- Adesione super forte
- Alta viscosità.
- Indurimento extra rapido
- Per filettature fino a: M36
- Tolleranze (D-d) 2 in m/m: Raccomandazione: 0.05 Max: 0.15
- Metallo / metallo: 5-20 min.
- Tempi di asciugatura: 3-6 ore
- Resistenza alla temperatura: -60°C + 150°C

> **DL6.41**  50 ml

**GEL PER CONTENIMENTO LIQUIDI PER CUSCINETTI 50 ML**

Colore: Giallo



**SPECIFICHE**

- Applicazioni consigliate: contenimento, fissaggio di cuscinetti
- Aderenza moderata
- Media viscosità
- Indurimento rapido
- Per filettature fino a: M20
- Tolleranze (D-d) 2 in m/m: Raccomandazione: 0.05 Max: 0.12
- Metallo / metallo: 10-20 min.
- Tempi di asciugatura: 3-6 ore
- Resistenza alla temperatura: -60°C + 150°C



# ARREDO DA OFFICINA



> **DA2110**

**CARRELLO PORTAUTENSILI A 7 CASSETTI**

- Realizzato in lamiera d'acciaio
- Chiusura di ogni singolo cassetto
- Cassetti montati con guide telescopiche con cuscinetti a sfera
- Cassetti con blocco indipendente da chiusi
- Materiale interno del cassetto EVA
- Impugnatura robusta ed ergonomica
- Ruote in poliuretano Ø125 mm, 2 ruote girevoli con freno
- Frontale cassetto in finitura alluminio
- Serratura di sicurezza

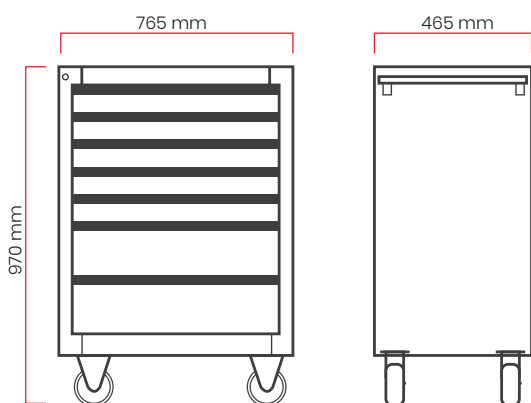

**NRS TOOLS**

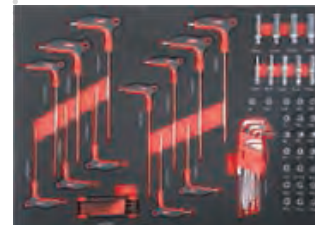

**DOTAZIONE 198 PEZZI**

Kit 1/4" - Kit 3/8" - Kit 1/2" - Prese 1/2" - Chiavi zigrinate offset - Chiavi combinate - Prese 1/4" - Chiavi a brugola - Punta per chiavi a brugola con impugnatura a T - Chiavi Torx - Cacciaviti con protezione - Cacciaviti - Pinze - Martelli



> **DA2210**

**CARRELLO PORTAUTENSILI A 7 CASSETTI**

- Realizzato in lamiera d'acciaio
- Chiusura di ogni singolo cassetto.
- Cassetti montati su guide telescopiche con cuscinetti.
- Cassetti con blocco indipendente da chiusi.
- Materiale interno del cassetto EVA.
- Impugnatura robusta ed ergonomica.
- Ruote in poliuretano Ø125 mm, 2 ruote girevoli con freno.
- Materiale delle parti CRV Cromo Vanadio
- Serratura di sicurezza.

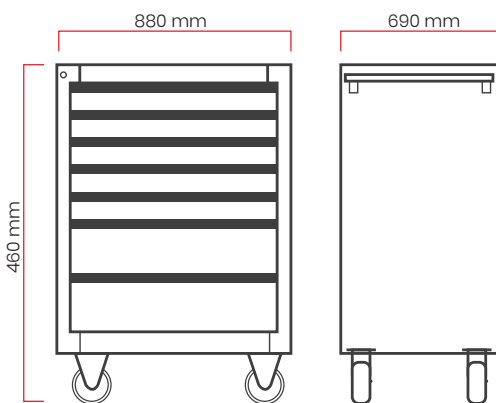
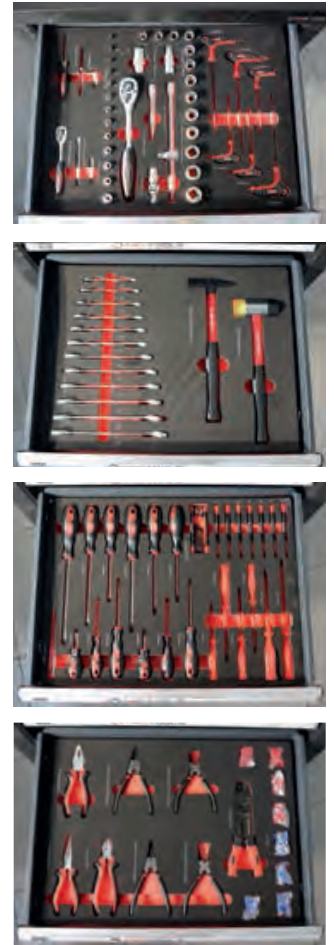

13 uds 1/4" - 1 Mango de llave 1/4dr - 1pc 1/4dr Barra deslizante - 2pcs 1/4dr Barra de extensión 2"&4" - 1pc 1/4dr Universal - 1 Mango de reenganche 1/4dr - 13 Piezas 1/2" dr down - 1pc 1/2dr Universal - 2pcs 1/2dr Toma de bomba de chispas 16 y 21 - Barra de extensión 2pcs 1/2dr- 1pc 1/2dr Junta de dos vías - Llave hexagonal de bola en t de 6 piezas - 1pc Probador - 12 Destornilladores - Destornillador de precisión 7pcs - Llave hexagonal 8pcs - Destornillador aislado 6pcs - Llave combinada de 12 piezas - 2 uds Martillo - 1 Alicata combinado - 1 Alicata de punta larga - 1 Alicata de corte lateral - 4 Alicates para arandelas - 1 Alicata de prensado - 160 Piezas terminales



## > DA2030

### CARRELLO A TRE VASSOI

- Dimensioni: 850 X 380 X 780 mm
- Misure vassoio: 745 x 380 x 80 mm
- Capacità: 14 kg

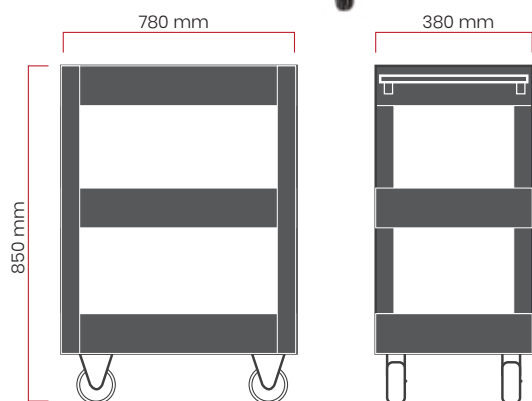

## > DA1202

### BANCO DI LAVORO

- Top in legno
- Base di acciaio robusta
- Dimensioni: 855 X 1340 X 455 mm
- Banco di lavoro ergonomico

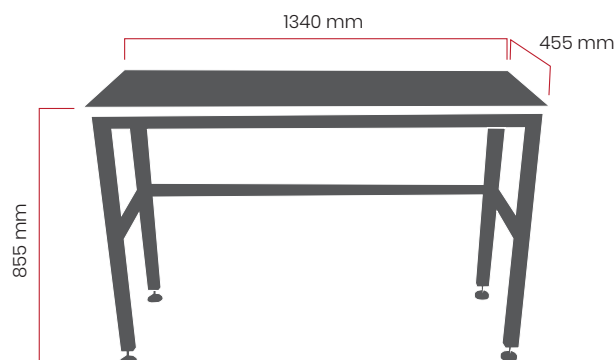

## > DA1292

### ORGANIZZATORE BOCCOLE PER CHIAVE 1/4"

- Materiale: PP + base magnetica
- 26 fori metrici



> **DA2012**

**CARRELLO A 5 CASSETTI SENZA UTENSILI**

- Misure del carrello montato: 69 x 33 x 77.2cm
- Misure dei cassetti: 51 x 29 x 10 cm

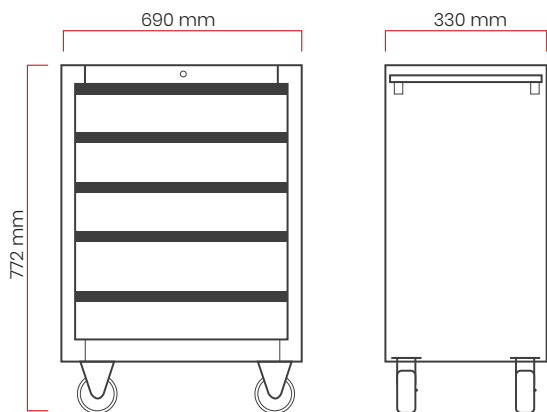

> **DA1210KIT**

**MODULI CENTRALI**

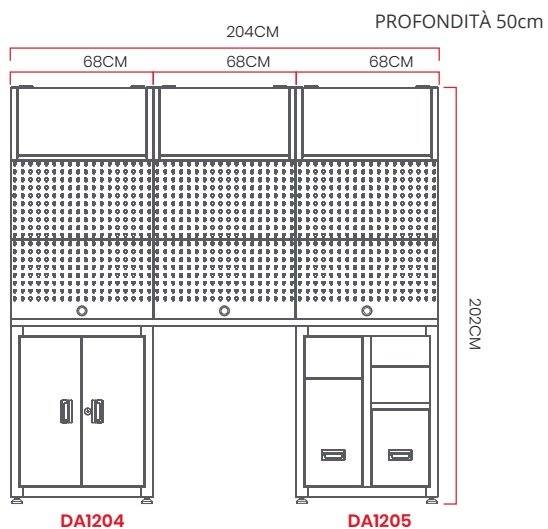



> **DA1220KIT**

**MODULI CENTRALI**

 128,5KG



> **DA1220L**

**MODULI LATERALI**

 39,7 KG





**IDRAULICA**



## > T840030D

**MARTINETTO IDRAULICO 3 T**  
DOPPIA POMPA, SOLLEVAMENTO  
PIÙ RAPIDO

**3T**



3 T



133 mm



465 mm



30,7 KG



## > T840025D

**MARTINETTO A PAVIMENTO PROFILO  
IDRAULICO BASSO 2,5 T**  
EXTRA PIATTO, DOPPIA POMPA, SOLLEVA-  
MENTO PIÙ RAPIDO

**2,5T**



2,5 T



75 mm



505 mm



35,2 KG



## > T840025D-RN





**RUOTE IN NYLON PER 25 D (SET DA 4)**



> **T830030PRO**

**MARTINETTO A PAVIMENTO PROFILO IDRAULICO BASSO 3 T**  
EXTRA PIATTO, DOPPIA POMPA, SOLLEVAMENTO PIÙ RAPIDO



-  3 T
-  95 mm
-  500 mm
-  40,5 KG





> **DA2107**

**MARTINETTO A PAVIMENTO PROFILO IDRAULICO BASSO 2,5 T**  
**CON PEDALE**  
EXTRA PIATTO, DOPPIA POMPA, SOLLEVAMENTO PIÙ RAPIDO,  
PEDALE



**2,5T**



-  2.5 T
-  75 mm
-  510 mm
-  35,2 KG



> **DA2126**

**SUPPORTI PER MARTINETTO DI BLOCCO A CRICCHETTO 3 T / SET 2 UN**

- REGOLAZIONE FACILE E SICURA
- BASE LARGA PER UNA MAGGIORE STABILITÀ
- SI ADATTA ALLA MAGGIOR PARTE DEI VEICOLI



> **DA2126B**

**SUPPORTI PER MARTINETTO DI BLOCCO A CRICCHETTO 6 T / SET 2 UN**

- REGOLAZIONE FACILE E SICURA
- BASE LARGA PER UNA MAGGIORE STABILITÀ
- SI ADATTA ALLA MAGGIOR PARTE DEI VEICOLI



> **DA2126C**

**SUPPORTI PER MARTINETTO DI BLOCCO A CRICCHETTO 12 T / SET 2 UN**

- REGOLAZIONE FACILE E SICURA
- BASE LARGA PER UNA MAGGIORE STABILITÀ
- SI ADATTA ALLA MAGGIOR PARTE DEI VEICOLI







> **DA2126**

**GRU 2T**







-  2 T
-  150 mm
-  2170 mm
-  82 KG

> **DA2126B**

**GRU PROFILO BASSO 1T**





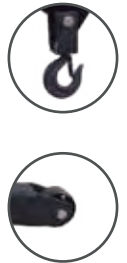

-  1 T
-  80 mm
-  2500 mm
-  86 KG



> **DA2126**

**MARTINETTO TRASMISSIONE 500 KG**





-  500 KG
-  1189 mm
-  2000 mm
-  32 KG



> **DA2126B**

**ACCESSORI CAMBIO**



-  500 KG
-  Ø30
-  12,70 KG



> **DA2018**

**PRESSA IDRAULICA 20 T**



**20T**

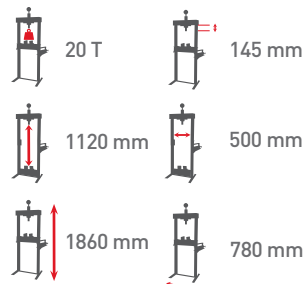

**KG** 90 KG

> **DA2019**

**PRESSA IDRAULICA 30 T**

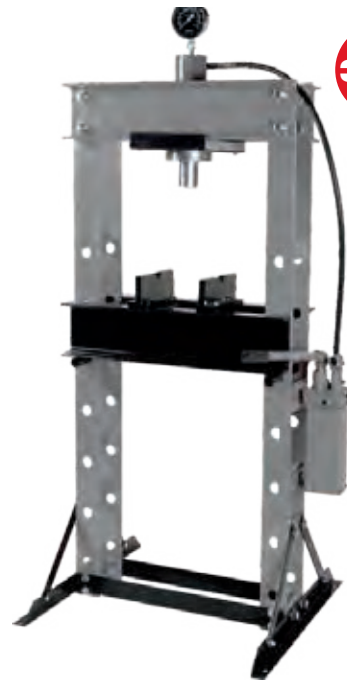

**30T**

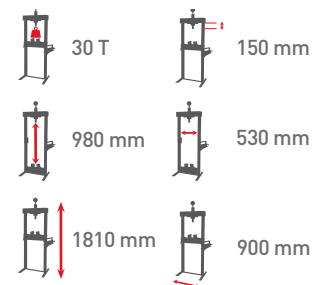

**KG** 147 KG

> **DA2020**

**PRESSA IDRAULICA 50 T**

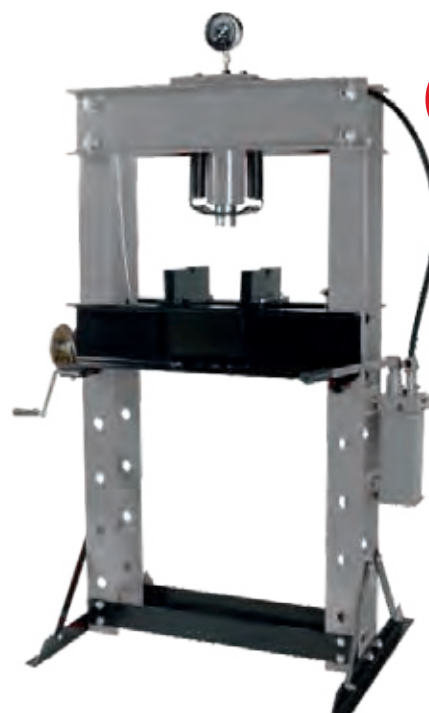

**50T**

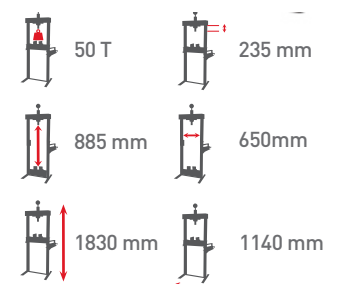

**KG** 224 KG

> **DA2121**

**PRESSA IDRO-PNEUMATICA 30 T**

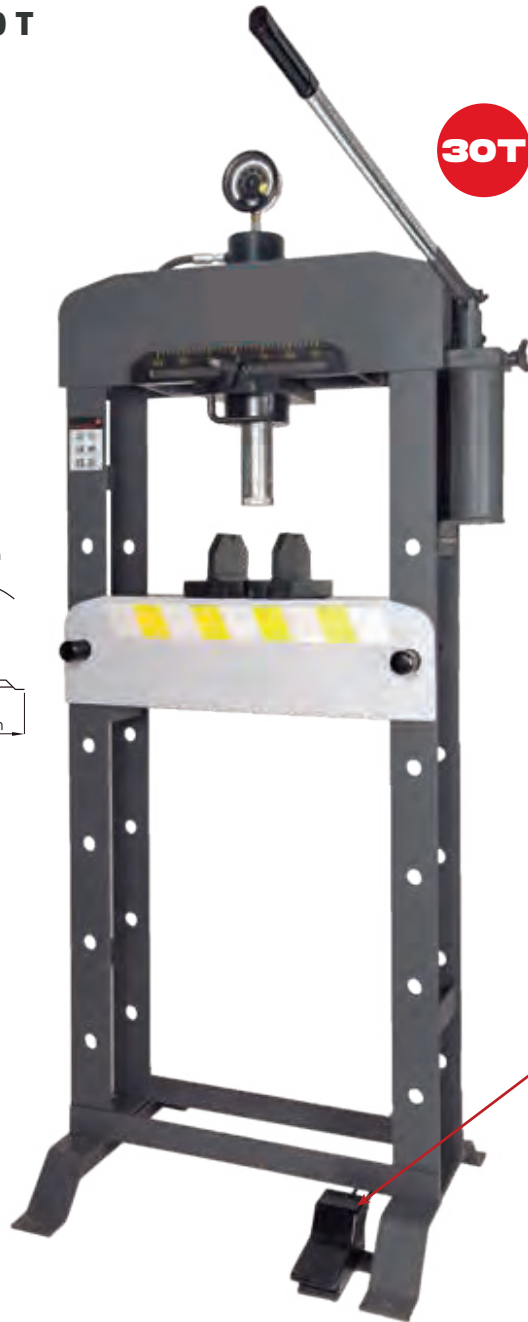

Set adattatori

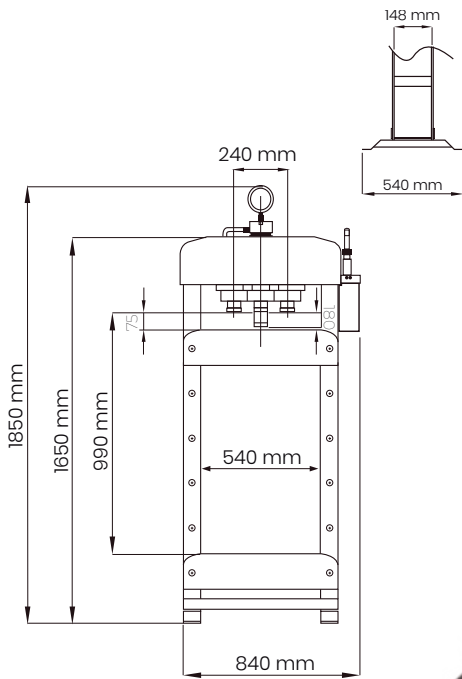

Pedale pneumatico

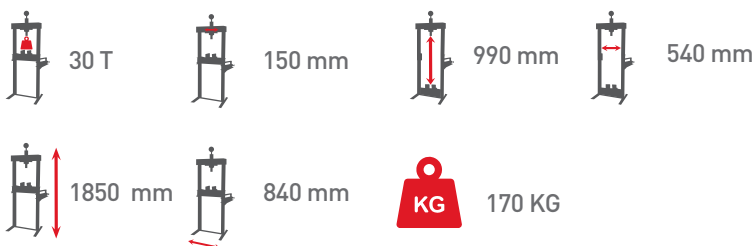

Schermo protettivo



## > DA2124

### COMPRESSORE IDRAULICO A MOLLA 1 T

#### SPECIFICHE

- Capacità: 1000 kg
- Lunghezza max di lavoro: 490 mm
- Corsa cilindro: 325 mm
- Dimensioni sede: 4-6-1/2"

 33 KG



## > DA2095

### COMPRESSORE IDRAULICO A MOLLA MCPHERSON

#### SPECIFICHE

- Dimensioni: 1320 x 690 x 520 mm
- Gioco base superiore: 226 mm
- Gioco base inferiore: 240 mm

#### ACCESSORI INCLUSI:

- Staffa di ancoraggio (1): 30 - 70 mm
- Supporto (2): Ψ 75 - 110
- Supporto (3): Ψ 110 - 140
- Supporto (4): Ψ 140 - 190



 112 KG



> **DA2116**

**PEDANA - POMPA OLIO - PNEUMATICA**

- Pressione di esercizio: 70 MPa
- Serbatoio olio: 1,6 l



**KG** 8,4 kg

> **DA2029**

**DISPOSITIVO DI POSIZIONAMENTO PL 12" / SET 2 UNITÀ**

- Capacità: 680 kg
- Larghezza: 12"
- Corsa: 275 mm
- Range di lavoro: 345 - 620 mm



**KG** 18 kg

> **DA2029-P**

**SUPPORTO PER DISPOSITIVO DI POSIZIONAMENTO**



> **DA2015**

**POMPA IDRAULICA**

- Capacità: 10T



> **DA2113**

**KIT CARROZZERIA 4T**

SPECIFICHE

- Capacità: 4T
- Corsa: 125 mm
- Altezza minima: 270 mm
- Dimensioni: 600 x 340 x 180mm



**4T**

**KG** 18 kg

> **DA2114**

**KIT CARROZZERIA 10T**

SPECIFICHE

- Capacità: 10 T
- Corsa: 135 mm
- Altezza minima: 358 mm
- Dimensioni: 740 x 420 x 170 mm



**10T**

**KG** 31 kg



> **DA2134**

**PIANO DI SOLLEVAMENTO 300 KG**



**300 KG**



300 KG



500 x 810 mm



270 mm



760 mm



64 KG

> **DA2135**

**PIANO DI SOLLEVAMENTO 500 KG**



**500 KG**



500 KG



500 x 815 mm



280 mm



860 mm



79 KG

> **DA2136**

**PIANO DI SOLLEVAMENTO  
1000 KG**

**1000 KG**



1000 KG



500 x 1000 mm



415 mm



1000 mm



112 KG



**PNEUMATICA**









> **DA402EL**

**MARTINETTO  
IDRO-PNEUMATICO  
INDUSTRIALE**



**40/20T**







-  20 T / 40 T
-  0,8-1,2MPa
-  150 mm
-  409 mm
-  40 T (73 mm)  
20 T (66 mm)
-  75 + 45 mm
-  40 KG

> **DA403JQL**

**MARTINETTO  
IDRO-PNEUMATICO  
INDUSTRIALE**



**40T/20T/10T**







-  40 T / 20 T / 10 T
-  0,8-1,2MPa
-  130 mm
-  409 mm
-  40 T (57 mm)  
20 T (49 mm)  
10 T (53 mm)
-  75 + 45 mm
-  44 KG

> **DA802J**

**MARTINETTO  
IDRO-PNEUMATICO  
INDUSTRIALE**



**80/50T**







-  80 T / 50 T
-  0,8-1,2 MPa
-  230 mm
-  563 mm
-  80T (111 mm)  
50T (102 mm)
-  75 + 45 mm
-  106 KG

> **DA301H**

**MARTINETTO  
IDRO-PNEUMATICO  
INDUSTRIALE**



**30T**

-  30 T
-  0,9-1,2 MPa
-  360 mm
-  770 mm
-  267 mm
-  100 + 45 m
-  87 KG



> **DA2T2L**

**MARTINETTO LUNGO  
PNEUMATICO  
BALOON**



**2T**



> **DA2T2S**

**MARTINETTO  
CORTO BALOON**



**2T**

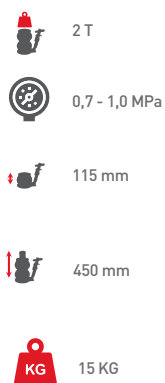

> **DA2036**

**SERBATOIO  
GONFIAGGIO  
19 LITRI**

- Azionamento rapido
- Doppia uscita aria
- Capacità: 19 l
- Pressione massima: 10 bar
- Pressione di esercizio: 6 - 8 bar

**KG** 13 KG



> **DA5015A**

**BOBINA AD ARIA  
3/8" 15 M**

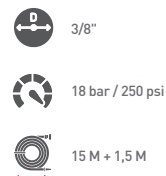

**15M**



> **DA5010E**

**BOBINA ELETTRICA  
10 M**



**10M**





## > DA1350

### GENERATORE DI AZOTO SEMI-AUTOMATICO

- Purezza N2: 95 - 99%
- Pressione ingresso aria: 9 - 10 bar
- Fabbisogno compressore aria: 5.5 - 7.5 kw / 10 bar / 1 - 1.5 m3/min
- Pressione uscita azoto: 1 - 6 bar
- Capacità uscita: 30 - 50 l/min
- Capacità serbatoio N2: 50 L
- Dimensioni: 620 x 445 x 1145 mm

**KG** 77 kg



## > DA1370A/EN

### GENERATORE DI AZOTO AUTOMATICO

- Purezza N2: 95 - 99%
- Pressione ingresso aria: 9 - 10 bar
- Fabbisogno compressore aria: 5.5 - 7.5 kw / 10 bar / 1 - 1.5 m3/min
- Pressione uscita azoto: 1-6 bar
- Capacità uscita: 50-70 l/min
- Capacità serbatoio N2: 50 L
- Dimensioni: 620 x 445 x 1145 mm

**KG** 94 kg





# LUBRIFICAZIONE



## > DA0080

### ASPIRATORE OLIO 80 L

- Capacità serbatoio: 80 l
- Capacità coppa: 16 l
- Pressione aria scarico: 0.7-1 bar
- Range di temperatura olio: 40-60 °C



## > DA2081

### COLLETTORE OLIO

- Capacità serbatoio: 65 l
- Capacità coppa: 16 l
- Pressione aria ingresso: 6-8 bar
- Collegamento ingresso aria: 1/4"
- Pressione aria scarico olio: 0.7 - 1 bar
- Range di temperatura olio: 40-60 °C
- Altezza massima: 1680 mm
- Altezza minima: 1025 mm



## > SA0079

### ACCESSORI OPZIONALI

Ampliamento coppa

- Diametro totale: 550 mm



## > DA7103 3:1

## > DA7105 5:1

### KIT MOBILE CON POMPA DELL'OLIO A PRESSIONE 3:1 / 5:1

INCLUSO

- Pompa dell'olio con rapporto di pressione 3:1 o 5:1
- Contatore digitale
- Carrello per fusti da 180-200 kg.
- Tubo dell'olio 1/2"x4 m



## > DA1900

### CARRELLO PER FUSTI

Carrello per fusti 180-200 kg



- > **DA70031** 3:1
- > **DA70051** 5:1

### POMPA DELL'OLIO 3:1 / 5:1

- Lunghezza tubo: 940 mm
- Pressione aria: 3-8 bar
- Portata massima per esercizio continuo: 27 l/min
- Portata massima con tubo da 4 m e ugello: 18 l/min
- Portata massima con tubo da 4 m e ugello: 34 mm
- Ingresso aria: Presa rapida
- Uscita aria: 1/2" BSP
- Pressione: 3:1 - 5:1



**KG** 12 KG

- > **DA7096**

### TUBO IDRAULICO



- > **DA7096**

### PISTOLA DOSATRICE DIGITALE

- Range di misura: 1 - 30 l/min
- Pressione di esercizio max: 70 bar
- Pressione di esercizio min: 3 bar
- Uscita aria: 1/2" BSP



- > **DA432**

### ESTRATTORE LIQUIDO FRENI

- Capacità serbatoio: 6 l
- Pressione massima OLIO: 3 bar
- Valvola di sicurezza: 4 bar
- Lunghezza tubo: 5 m

CASSETTA ACCESSORI INCLUSA



**KG** 8,9 KG

# MARCHIO PREFERITO SUI SOCIAL MEDIA

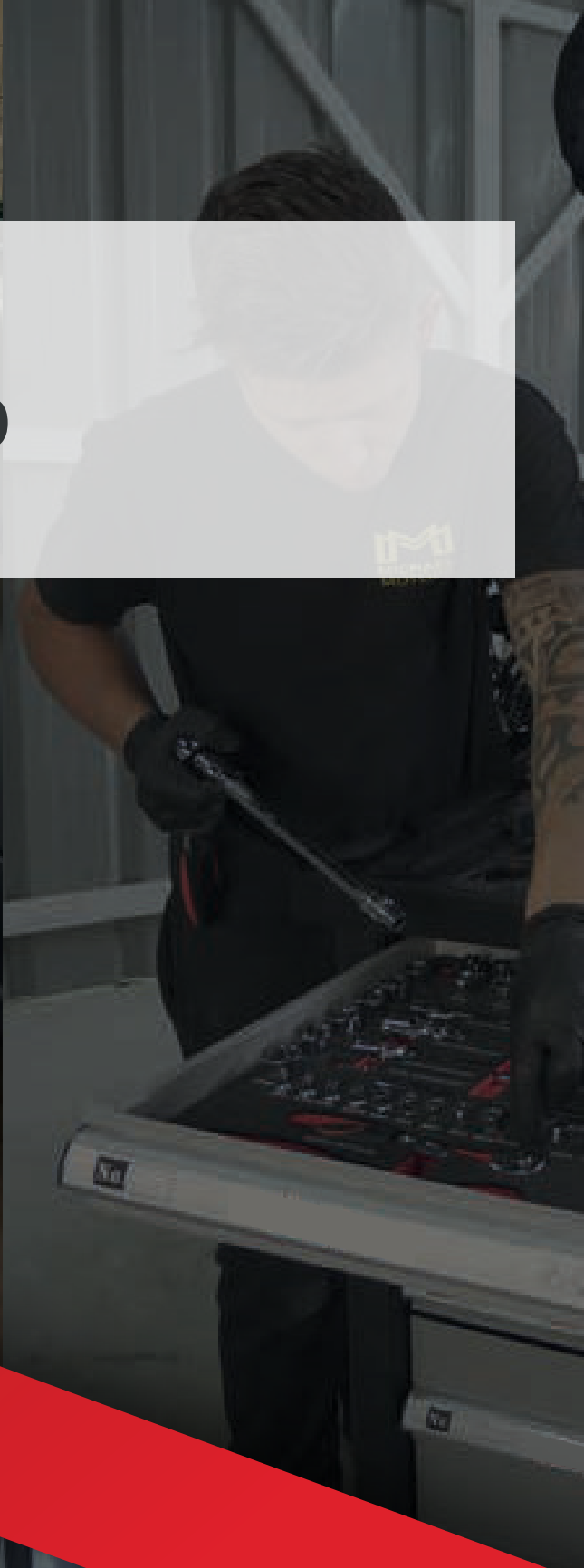



**ACCESSORI  
OFFICINA**



## > DA2031

### LETTIGA PIEGHEVOLE

 460 x 160 x 480 mm

 6,5 KG



## > DA2032

### SEDE IN ACCIAIO

 368 x 360 x 365 mm

 3,8 KG



## DA2033

### LETTIGA PIEGHEVOLE

- Capacità: 110 kg
- Ruote: 6 pz da 2"
- Dimensioni di ingombro: 90.5x41.5x8.5 cm
- Altezza piegato: 35.5 cm
- Lunghezza: 36"





> **DA2042**

**SMONTAGOMME MANUALE**

SPECIFICHE

- Capacità max: 17"

**include:**

- - Lama stallonatore
- - Impugnatura stallonatore
- - 2 barre



> **DA2125**

**ELEVATORE MOTO MANUALE**



> **DA2044**

**SUPPORTO MOTO**

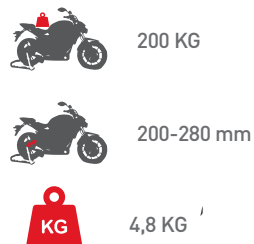



> **DA2138**

**MARTINETTO MOTO**

 500 KG

 90 mm

 405 mm

 14 KG



> **DA2006**

**SUPPORTO MOTORE**

 565 KG

 29,9 KG



> **DA2043**

**PORTAROTOLO**



 2,25 KG

> **DA2046**

**SUPPORTO MOTORE 0,5T**



 500 KG

 1500 mm

 20 KG

> **DA2039**

**LIVELLATORE GRU**

 680 KG

 5,5 / 6 KG



> **DA2041**

**LAVA PEZZI**

Spazzola inclusa

 75 L

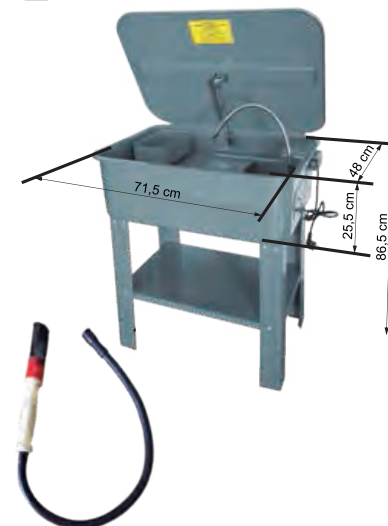

> **DA2040**

**CUNEI / SET 2 UNITÀ**

Cuneo in gomma

 105 x 75 x 75

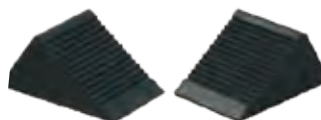



# STRUMENTI



## > DA1400F

### AVVITATORE - PISTOLA PNEUMATICA A IMPATTO DA ½" - 1495 NM

Selettore a 3 posizioni per il fissaggio

Carter ergonomico in composito per un lavoro confortevole

- Coppia massima: 1495NM
- Velocità di rotazione libera: 7500 rpm
- Consumo aria medio: 6,5 CFM



**1495 NM**

## > DA1402E

### AVVITATORE - PISTOLA A IMPATTO 20V CON BATTERIA AL LITIO 430 NM

- Motore brushless
- Tensione batteria: 20V
- Batteria agli ioni di litio
- Indicatore della batteria
- Design ergonomico
- Luce led incorporata
- Pistola a impatto + 2 batterie (4.0ah e 2.0ah)+ caricabatterie + prese (17, 19, 21 mm) e valigetta



**430 NM**



> **DA1216**

**SET ATTREZZI 215 PZ**

 1/2, 1/4, 3/8



> **DA1298**

**SET ATTREZZI 108 PZ**

 1/2, 1/4



> **DA1294**

**SET ATTREZZI 94 PZ**

 1/2, 1/4





## > DA3206

### SET DI 3 BOCCOLE A IMPATTO

17 mm      19 mm      21 mm



## > DA1250

### CHIAVE DINAMOMETRICA MANUALE 28-210 NM

- Coppia di serraggio: 28 Nm - 210 Nm
- Dimensioni adattatore: 1/2" (12.5 mm)
- Calibrato conformemente alla norma DIN EN ISO 6789
- Precisione:  $\pm 4\%$
- Testa a sgancio rapido
- Controdado





**ILLUMINAZIONE**



## > DA4001

### LAMPADA PORTATILE 350/180 LUMEN

- Illuminazione principale: LED COB 5W
- Illuminazione secondaria: LED SMD 3W
- Intensità massima: 350 lumen
- 2 modalità di illuminazione: Massima/anteriore
- Autonomia: 2.5 h/5 h
- Batteria: Ioni di litio 3,7 V - 2000 mAh
- Ricaricabile: USB (incluso)
- Tempo di caricamento: 3 h
- Regolatore di intensità
- Power bank



## > DA4002

### LAMPADA PORTATILE 160 / 50 LUMEN

- Illuminazione principale: LED COB 3W
- Illuminazione secondaria: LED SMD 3W
- Intensità massima: 160 lumen
- 2 modalità di illuminazione: Massima / Anteriore
- Autonomia: 2.5 h/3 h
- Batteria: Ioni di litio 3,7 V - 1200 mAh
- Ricaricabile: USB (incluso)
- Tempo di caricamento: 2.5 h

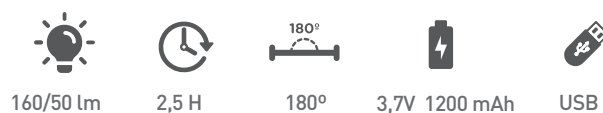



> **DA4004**

**LAMPADA PORTATILE SLIM - 250 / 600 LUMEN**

- Illuminazione principale/secondaria: LED COB, 250/600 lumen
- Illuminazione torcia: 120 lumen
- 2 modalità di illuminazione: Fiaccola/Torcia
- Batteria: Ioni di litio 3,7 V - 2600 mAh
- Fonte di luce: 6 W COB (anteriore) / 3 W SMD (torcia)
- Autonomia (anteriore): 5h 30 min / 2h 30 min
- Autonomia (fiaccola): 10h
- Tempo di caricamento: 4h
- Ricaricabile: USB (incluso)
- Indicatore di livello ricarica

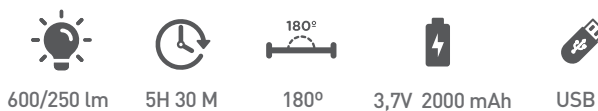



> **DA4004S**

**LAMPADA SLIM PIEGHEVOLE CON BASE DI RICARICA 600/200 LUMEN**

- Illuminazione frontale a LED: COB 600 lumen
- Illuminazione torcia a LED: 200 lumen
- 3 modalità di illuminazione: Torcia, anteriore e rossa
- Batteria: Ioni di litio 3,7 V 18650 - 2000 mAh
- Fonte di luce: COB 10W (anteriore) / LED 5W (torcia)
- Durata illuminazione (anteriore): 3 h
- Durata illuminazione (torcia): 3 h
- Ricaricabile tramite: Base di ricarica rapida e cavo USB (incluso)
- Richiede: DC5V-1A max (connettore USB)
- Tempo di caricamento: 3 h
- Indicatore di livello ricarica



600 lm



5H 30 M



180°



3,7V 2000 mAh



USB

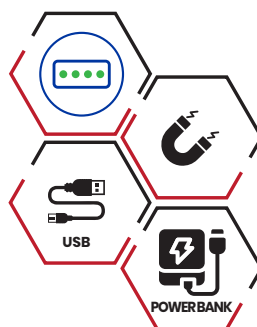

> **DA4006**

**FARO 1100 LUMEN**

- Illuminazione: 10W COB
- Batteria: Batteria agli ioni di litio 2x18650 3.7V 4400 mAh
- Regolazione: 100%-80%-60%-40%-20%
- Intensità massima: 1100 lumen
- Distanza fascio: 42 m
- Autonomia: 3 h (modalità 100%)
- Tempo di ricarica: 6 h
- Alimentazione: 5V 2A
- Dimensioni: 170x170x47,5 mm
- Peso netto: 702 g



1100 lm



3 H



180°



3,7V 4400 mAh



USB



Ah

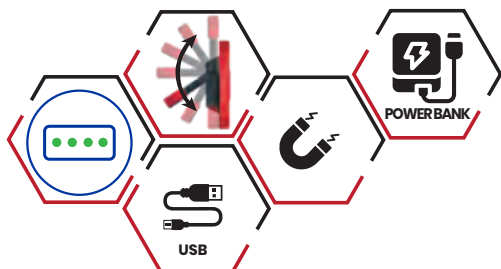



## > DA4007

### FARO - 260 / 100 LUMEN

- Illuminazione principale/secondaria: 260/100 lumen
- Sensore di movimento
- Batteria: Ioni di litio 3,7 V - 1800 mAh
- Ricaricabile: USB (inclusa)
- Tempo di ricarica: 3.5 h
- Autonomia: 3 h abbaglianti princ. / 9 h anabbaglianti princ.

#### 5 modalità di illuminazione:

- Abbaglianti
- Anabbaglianti
- Lampeggiante
- Luce rossa
- Luce rossa lampeggiante

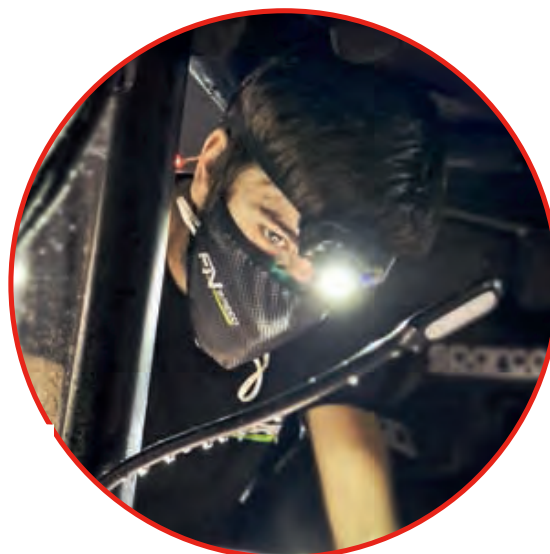
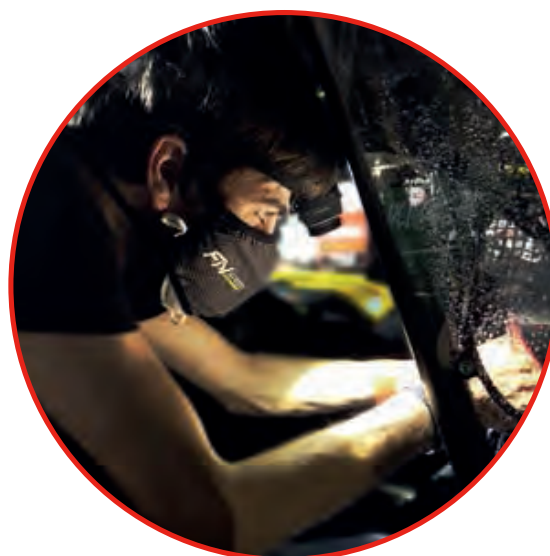
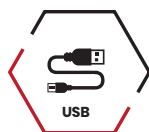
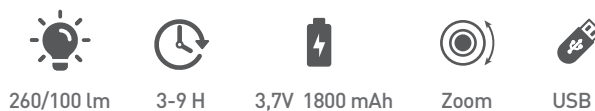

**> DA4008**

**LUCE COFANO - 500 / 1000 LUMEN**

- 2 intensità luminose: 500/1000 lumen.
- Basso consumo energetico, bassa generazione di calore.
- Struttura in alluminio, lunghezza regolabile da 115 a 182 cm.
- Indicatori del livello di carica della batteria.
- Distribuzione della luce a 180° senza ombre.
- P65/IK07 lavoro sicuro in ambienti difficili e resistente a colpi, urti e vibrazioni.
- Impugnatura in gomma antiscivolo, maneggevole ed ergonomica.

- Lumen: 1000/500
- CCT: 5650-6500K
- Autonomia: 3/6 ore
- Tempo di ricarica: 4.5 h
- IP: IP65
- IK: IK07
- Ingresso USB: 5V1A
- Batteria: 3.7V4400mAH
- Dimensioni: 1156x185x706 mm
- Peso netto: 800 g
- Gancio girevole: 360°
- Gancio estensibile: da 153 mm a 1820 mm

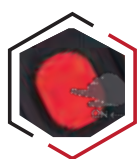
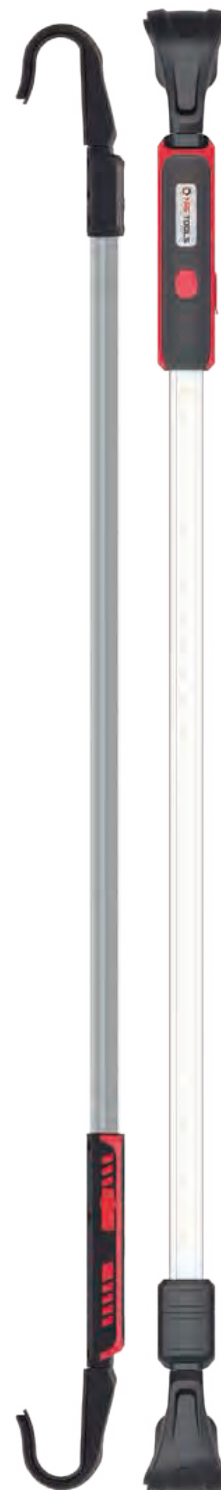

MICRO USB

ON / OFF



1000 / 500 lm



3 / 6 H



3,7V 4400 mAh



USB

## > DA4010

### KIT 2 LAMPADINE LED CON BASE A INDUZIONE

- Fissaggio: Magnete
- Intensità luce principale: 300 lumen
- Intensità luce anteriore: 35 lumen
- Durata di funzionamento: Luce principale ca. 300 lm 2h/35 lm 10h
- Tempo di ricarica: 2.5 h
- Alimentazione: Induzione
- Indicatore della batteria: Sì
- Peso della torcia: 160 g
- Peso netto 2 torce + base: 550 g



## > DA4010-L

### KIT LAMPADA PORTATILE UNITÀ DA4010



## > DA4010-IND

### KIT BASE A INDUZIONE DA4010 DUAL



## > DA4112

### LUCE DI EMERGENZA/ FARO

- Lampada di segnalazione di emergenza, incidente o guasto su strada.
- Design compatto
- Visibilità: fino a 1 km
- Impermeabile. Omologazione IP65
- Funziona con 1 batteria da 9V (non inclusa)





**PULIZIA, PROTEZIONE  
E DISPOSITIVI DI  
PROTEZIONE INDIVIDUALI**



## > DA1523

### KIT DI PROTEZIONE 5 IN 1

- Kit di protezione per veicoli
- Protezione del volante
- Protezione leva cambio
- Protezione del freno di stazionamento
- Protezione del sedile
- Protezione del pavimento



## > DF100

### GEL IGIENIZZANTE 100 ML

Gel che miscela sinergicamente agenti idratanti per la pelle e ingredienti con effetto igienizzante per aiutare a mantenere le mani pulite e al riparo dagli agenti patogeni. In caso di sporco ostinato, si consiglia di lavarsi prima le mani con acqua e sapone. Quando le mani sono pulite, applicare questo gel per mantenerle idratate e igienizzate.

- Aspetto: gel incolore ad alta viscosità
- Odore: caratteristico
- pH (al 100%):  $4,5 \pm 0,5$
- Densità:  $1,02 \pm 0,01$  g/ml a  $20^{\circ}\text{C}$
- Capacità: 100 ml
- Unità per scatola: 120 unità



100 ml



> **DF500**

**GEL IGIENIZZANTE 500 ML**

Detergente mani igienizzante senza risciacquo.

Pulizia completa delle mani senza risciacquo grazie al contenuto di alcol etilico (70%). Uso esterno. Applicare su pelle non lacerata. Non ingerire. Evitare il contatto con gli occhi. Tenere fuori dalla portata dei bambini. Infiammabile.

- Aspetto: gel incolore ad alta viscosità
- Odore: caratteristico
- pH (al 100%): 4,5 ± 0,5
- Densità: 1,02± 0,01 g/ml a 20°C
- Capacità: 500 ml
- Unità per scatola: 20 unità



500 ml

> **GELHIDROSEV.5L**

**DETERGENTE MANI IDRO-ALCOLICO 5 LITRI**

Detergente mani igienizzante senza risciacquo.

Pulizia completa delle mani senza risciacquo grazie al contenuto di alcol etilico (70%). Uso esterno. Applicare su pelle non lacerata. Non ingerire. Evitare il contatto con gli occhi. Tenere fuori dalla portata dei bambini. Infiammabile.

- Colore: blu
- Aspetto: idrogel
- Odore: caratteristico

**COMPOSIZIONE:**

- |                    |        |
|--------------------|--------|
| • INCI             | (%)    |
| • Alcol denaturato | 70%    |
| • Acqua            | 25-30% |
| • Glicerina        | 0-5%   |
| • Gomma cellulosa  | 0-19%  |
| • IC 42090         | 0-0.1% |



5 l



## > DA1530-D

### TERMOMETRO INFRAROSSI

- Range di temperatura corporea: da 35.0 °C a 42.0 °C da 95.6 a 107.9 °F
- Range di temperatura delle superfici: 0 °C TO 100 °C/32 TO 212 °F
- Risoluzione display: 0.1°C/0.1°F
- Distanza di misura: 3 - 5 cm
- Tempo di risposta: 0.1 s
- Alimentazione: DC3V (batterie 2\*AA)
- Condizioni di stoccaggio: -20°C -55°C
- Umidità relativa: <93%



## > OZ10-1

### GENERATORE DI OZONO

L'ozono agisce come disinfettante e antisettico, eliminando batteri, virus, odori, ecc.

- Uscita ozono: 10000 mg
- Potenza: 126 w
- Flusso dell'aria: 260 m3
- Tensione: 220V
- Area di lavoro: 80 -120 m2
- Tempo veicolo: 10 -15 min
- Timer: 1-60 minuti
- Peso lordo: 3.8 kg/pz
- Dimensioni: 323 \* 162 \* 184 mm
- Generatore di ozono per aria commerciale
- Durata pre-filtro piastra ozono: 10000 h

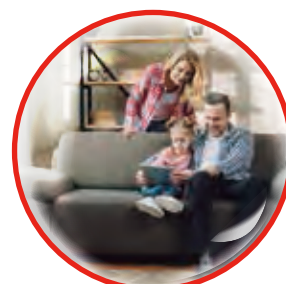

**NOTE:**

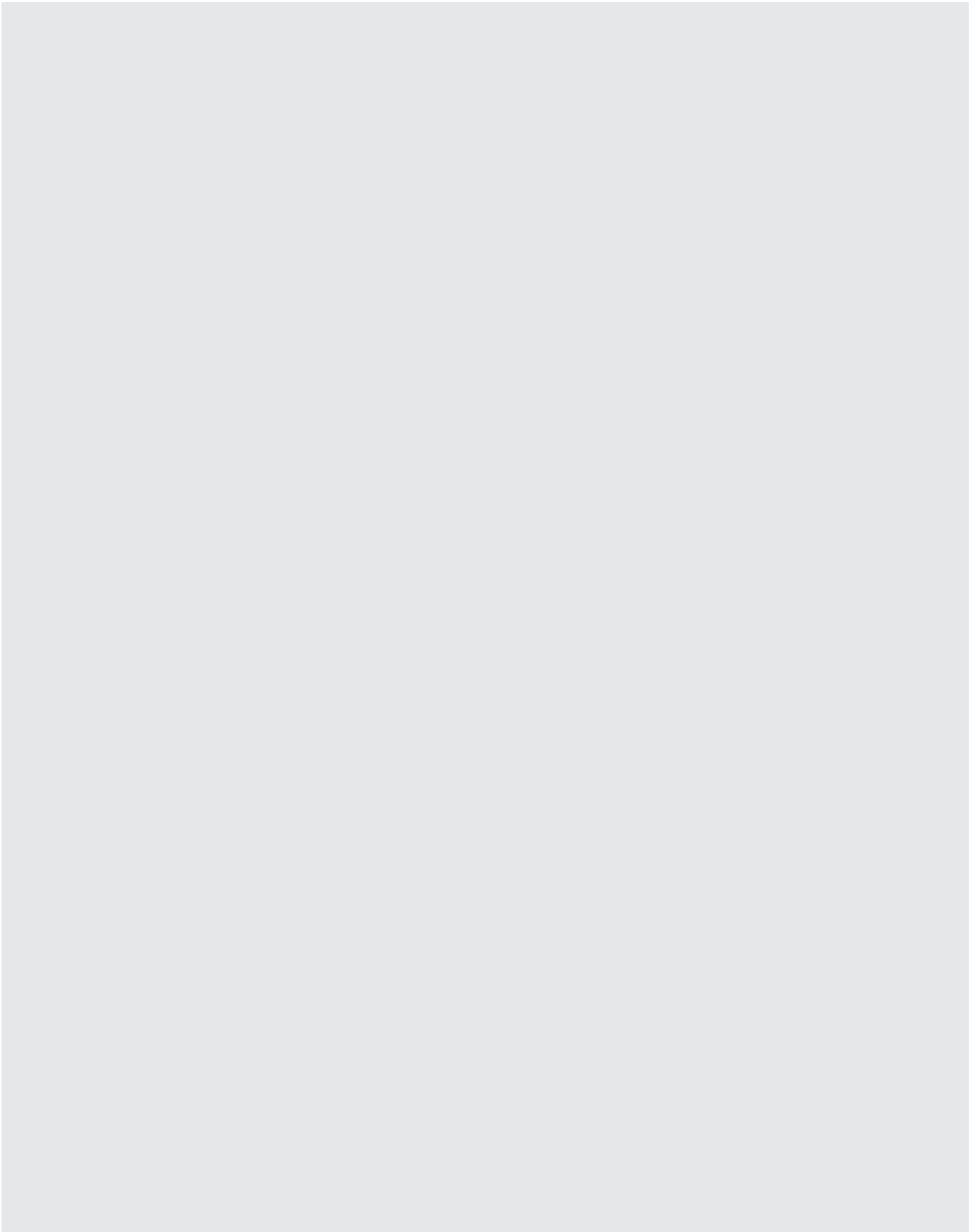



**Global Team**  
AUTOMOTIVE SPECIAL TOOLS

**GLOBAL TEAM s.r.l.**

Via Antonio Meucci 9/11 - 24051 Antegnate (BG) - ITALY  
T +39 0363 905769 - F +39 02 4074 6151  
P.I.0567916 0969

[www.globalteam-tools.com](http://www.globalteam-tools.com)



N° 50100-13304